

ARBOGA



A 2608 M



	Ø 25 / 28 mm		50Hz 105-210 350-700 445-890 1460-2900	60Hz 130-260 420-840 535-1070 1740-3480
	130 mm		0,65/0,90 kW	0,80/1,10 kW
	M16 / M20		mm/r 0,10 0,15 0,22 0,30	inch/r 0,004 0,006 0,009 0,012
	MK 3			
	500 x 400 mm			



195

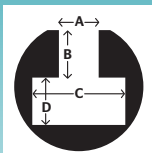

A 14,5 +/- 0,8 mm
B 13 mm
C 26 mm
D 12 mm

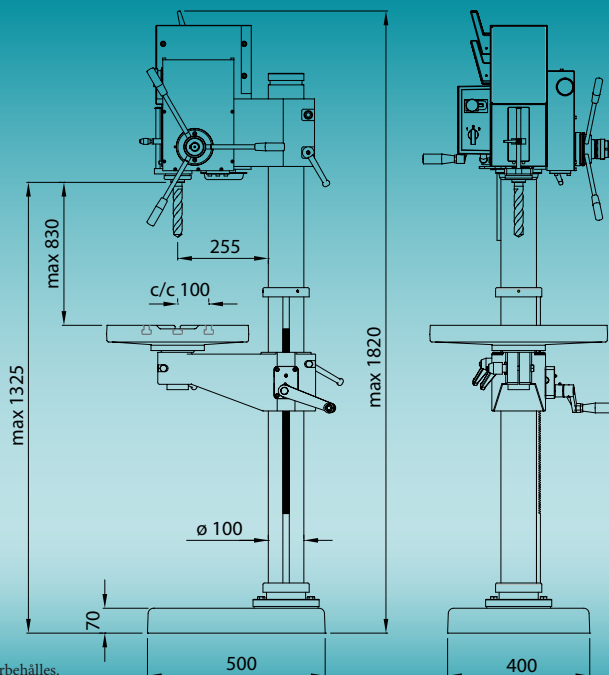

Rätt till ändringar av tekniska data utan föregående meddelande förbehålles.
We reserve the right to make modifications without prior warning.
Das recht auf Änderung der vorstehenden Daten behalten wir uns vor.

Tillbehör A 2608 M

Spare parts/Zubehör

ARBOGA
2011



T25095

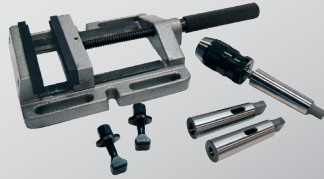

T25000



T25003

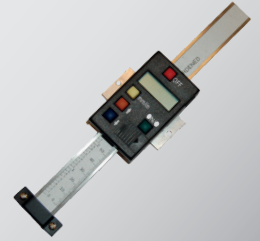

T25012

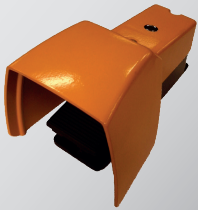

T25009

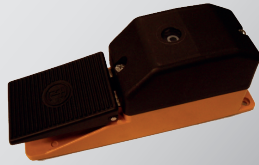

T25010

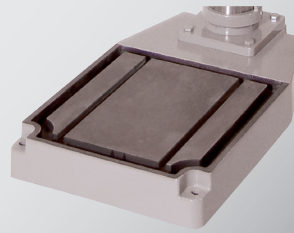

T25011



T25013



T25021

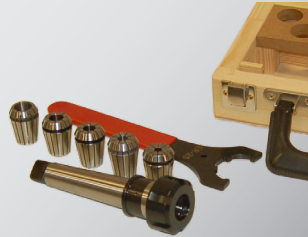

T25U42



T30040 0-13 mm



T30041 3-16 mm

Std EU

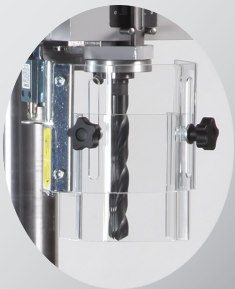

T25014 + T25052

SANDFELD[®] AS
VÆRKTØJSMASKINER

Birkegårdsvej 2 · 7400 Herning · Denmark · Phone +45 97 11 92 22 · www.sandfeld.com

MSC
machinery scandinavia
MADE IN SWEDEN

ROSENFORS
MADE IN SWEDEN

Machinery Scandinavia AB
577 97 Rosenfors, Sweden
Tel +46 495 49 700
E-mail: sales@mscab.se
www.arbogamachinery.com