



str/nds

S 30 M

	Ø 30 / 32 mm		50Hz 75-160 265-535 440-890 1480-3010	60Hz 90-190 320-640 530-1060 1790-3610
	150 mm		0,90/1,20 kW	1,10/1,50 kW
	M18 / M22		mm/r 0,10 0,15 0,22 0,30	inch/r 0,004 0,006 0,009 0,012
	MK 3			
	500 x 400 mm			



270

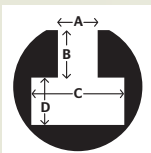

A 14,5 +/- 0,8 mm
B 13 mm
C 26 mm
D 12 mm

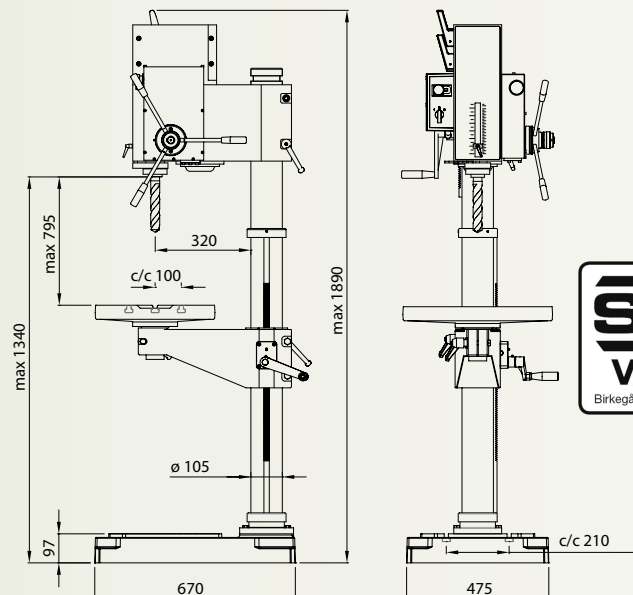

MSC
Machinery
Scandinavia

Rätt till ändringar av tekniska data utan föregående meddelande förbehålles.
We reserve the right to make modifications without prior warning.
Das recht auf Änderung der vorstehenden Daten behalten wir uns vor.