



str/nds

S 40

			50Hz	60Hz
	Ø 40 mm		90-135 200-300 440-670 980-1500	108-162 240-360 528-805 1175-1800
	190 mm		2,20 kW	2,60 kW
	M24 / M28			
	MK 4			
	500 x 400 mm			



330

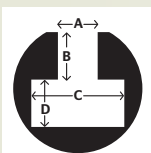

A 14,5 +/- 0,8 mm
B 13 mm
C 26 mm
D 12 mm

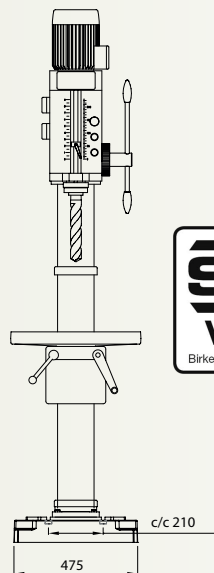
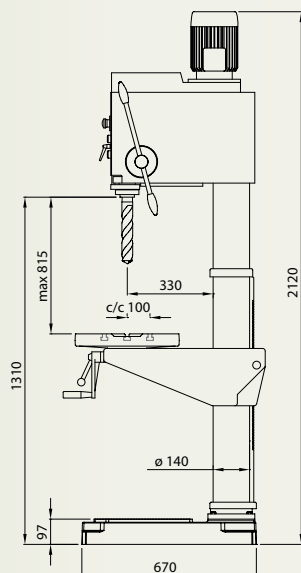

MSC
Machinery
Scandinavia

Rätt till ändringar av tekniska data utan föregående meddelande förbehålles.
We reserve the right to make modifications without prior warning.
Das recht auf Änderung der vorstehenden Daten behalten wir uns vor.

Tillbehör S 40 ME

Spare parts/Zubehör

strands



T35000



T25003



T40005



T30006

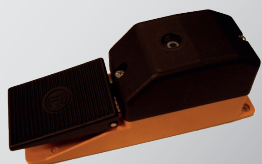

T40010



T40013



T40030 - 60 - 980 rpm

T40031 - 180 - 3000 rpm

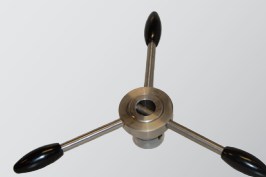

T40014

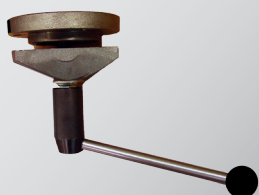

T40021



T40020



T40022

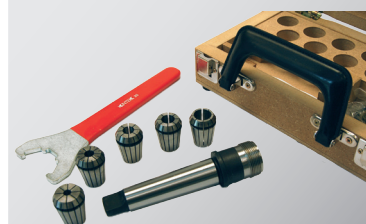

T40042



T40040 0-13 mm



T40041 3-16 mm



TFÄRGO

Std EU

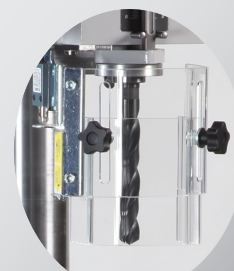

T40051 + T25052

MSC 
Machinery
Scandinavia

Machinery Scandinavia AB
570 83 Rosenfors, Sweden
Tel +46 495 49 700
Fax + 46 495 207 30
E-mail: sales@mscab.se
www.strandsmachinery.com

SANDFELD 
VÆRKTØJSMASKINER
Birkegårdsvej 2 · 7400 Herning · Denmark · Phone +45 97 11 92 22 · www.sandfeld.com